

Upgraded control, acquisition program and user interface for the Manchester Echelle Spectrometer at San Pedro Mártir.

L. Gutiérrez^{a*}, J. Murillo^{b*}, F. Quiroz^{c*}, M. H. Pedrayes^{d*}, J. Meaburn^{e**} and J. A. López^{f*}

^{*}Observatorio Astronómico Nacional/UNAM; ^{**}University of Manchester.

ABSTRACT

We describe the recent upgrade of the Manchester Echelle Spectrometer, currently in use at San Pedro Mártir. This upgrade has included a user interface and a new CCD acquisition software. The spectrometer control is now done by a microcontroller, whose inputs are new sensors and encoders installed inside the spectrometer. The instrument control is now fully carried out from a graphical user interface running in a personal computer. The acquisition computer sends the images to the GUI through an ethernet link. In this paper, we present the general scheme and the programs developed for Linux (in C++ and Tcl/Tk) that permits an easy integral operation of the instrument, as well as the creation of scripts intended to the optimization of the observing run and the future interaction with the telescope and the guider. This upgraded system has been operated successfully during several campaigns in the 2.1-meter telescope at Observatorio Astronómico Nacional in San Pedro Mártir.

Keywords: Spectrometer, GUI, sequences.

1. INTRODUCTION

To study problems which require the detection of faint light in many spatial elements simultaneously, within very small wavelength ranges but at high spectral resolution, Meaburn et al.¹ developed a spectrometer for the Anglo-Australian Telescope. In the beginning, it was operated in combination with the image photon counting system (IPCS), which has now been replaced by a CCD camera. This spectrometer, without cross-dispersion, isolate individual echelle orders with broad, efficient, interference filters and by employing predominantly transmission optics. A large fraction of an extensive emission line or continuous source can be covered by a long multi-slit mask, and profiles of emission or absorption lines can then be obtained from many spatial elements simultaneously. This spectrometer, first intended to the Anglo-Australian Telescope, has been installed now in the San Pedro Mártir 2.1m-Telescope and its astronomical applications have not changed; however, though its efficiency has been improved.

2. OPTICAL AND MECHANICAL SCHEME

We briefly review the main aspects of MES here. For a full description see Meaburn et al. (1984).

The optical scheme for the operation of this echelle spectrometer is shown in Figure 1 and a picture of the complete instrument is in Figure 2. A summary of the main optical parameters is shown in Table 1. In the main mode of operation, a lens composed of two separated doublets collimates the $f/7.5$ beam from the Ritchey-Chretien focus of the telescope, and refocuses it on the CCD, after dispersion by the echelle grating. All the air/glass transmission surfaces have been coated with broadband anti-reflection layers for maximum efficiency, loosing only 0.5 per cent of the incident light between 3900 and 7500 Å.

Mirror systems are generally preferred because of the chromatic aberrations inherent in lens systems, which become serious when a wide spectral range is to be covered. However, it is well known that the configuration used in this

^aleonel@astrosen.unam.mx, ^bmurillo@astrosen.unam.mx, ^cquiroz@astrosen.unam.mx, ^dpedrayes@astrosen.unam.mx, ^fjal@astrosen.unam.mx; Observatorio Astronómico Nacional, UNAM; Ensenada, BC, México; phone 0152646-174-45-93; fax 0152-646-174-46-07. ^ejm@ast.man.ac.uk; Department of Physics and Astronomy, University of Manchester, UK; phone 01477-57-12-31; fax 01477-57-16-18.

Spectrometer

Beam diameter	= 100 mm
Focal length	= 800 mm
Angle between central input and output beams	= 3.3°
Anti-reflected wavelength range	= 3900 - 7500 Å
Field area	= 25 x 30 mm = 5.4' x 6.5'
Max spectral resolution $\lambda/\Delta\lambda$	= $\sim 10^5$ for 24 micron pixels

Multi-slits

Length	= 30 mm
Separation	= 3.3 mm @ 5 elements (=6.6 @ 3 elements) = 43" (= 86")
Width	= 70, 150 microns = 0.91", 1.96"

Echelle Grating (Bausch and Lomb)

Blaze angle	= 63 26'
Grooves/mm	= 31.6
Dimensions of ruled area	= 128 x 254 mm

Table 1. A summary of the main optical parameters

spectrometer, a Petzval lens system formed by two close doublet lenses, rather widely separated, can be designed to give a high level of correction of spherical aberration, coma, and astigmatism over the field angles required.

A conventional slit assembly is placed in the spectrometer entrance. Depositing chromium on a thin glass substrate produces single long slits and long multislots. The maximum slit length is 30 mm (=6.5 arc min) and the separated slits are placed anywhere within a 25 mm (=5.4 arc min) width in a plate in the common focal plane. The plate has three places, one open and two for slits, in any combination. One useful combination is two long slits 70 microns and 150 microns width.

Also, there is an interference filter assembly to isolate one order of the echelle. There is space for four square filters with half power bandwidths as equal as possible to the separation of the echelle orders for the grating with a 63° 26' blaze angle, 31.6 groove/mm and 3.3° between the input and output optical axes. The filters are mounted on a plate that, as the slits plate, is moved by a linear Geneva mechanism. The installed interference filters are circular, 50-mm diameter and 7-mm thickness and they are the following: H α , SII, OIII and NII.

An additional wheel with five positions for optional polarizers or neutral density filters is placed before the focal plane. This wheel is moved by a rotary Geneva mechanism.

It is possible to illuminate evenly the slit area with light from a Thorium-Argon line lamp, for calibration, or a tungsten white light source for flat fielding. The Th-Ar lamp may emit sufficient lines to provide many in any wavelength range to simplify the calibration procedure.

To move the grating a worm gearing mechanism that rotates an eccentric cam is used; the cam pushes a spring loaded lever attached to the grating holder. To prevent any displacement greater than 3 microns of the spectrum on the detector, due to flexure of the spectrometer, the casting that separates the grating holder from the main box was designed to be sufficiently rigid.

The mirror is in front of the grating; it can be moved with a worm gearing mechanism driven by a motor (Figs. 3 and 4). In the previous design this was done pneumatically. When this mirror is in the optical path a direct image of the object can be acquired.

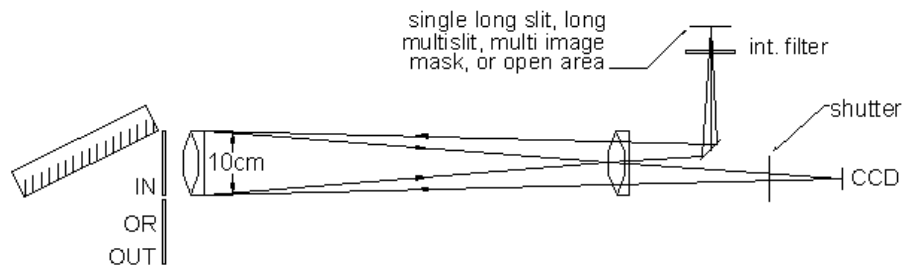

Figure 1. An echelle order is isolated by an interference filter, or with the excluding mirror in, a direct image of the field is formed.

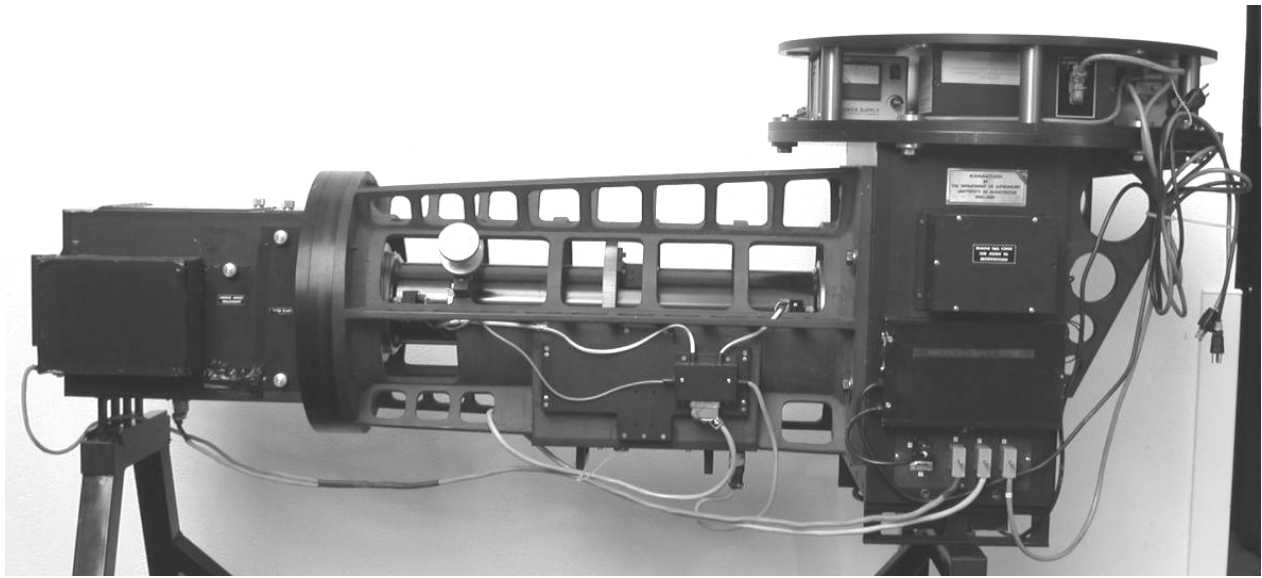

Figure 2. This is the spectrometer. CCD is attached in the right-hand side (not shown here).

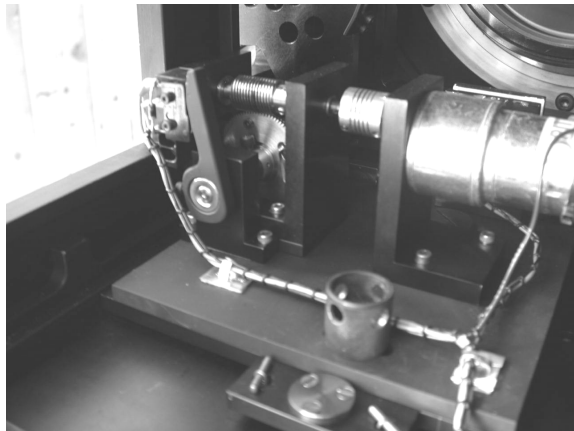

Figure 3. Mechanism that moves the excluding mirror. Rear view

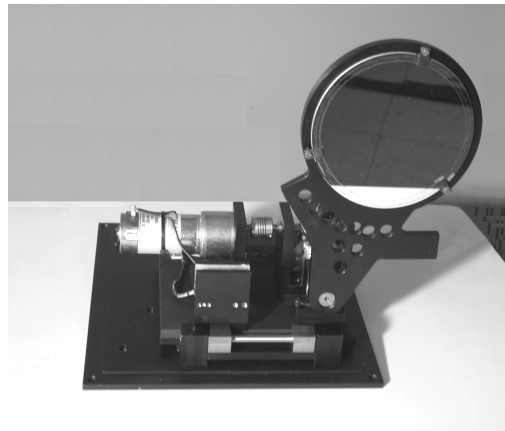

Figure 4. Front view of the same mechanism. Here is removed from the spectrometer.

3. ELECTRONIC LAYOUT

The overall electronic system in this spectrometer has been upgraded to operate it from a personal computer. All the operations are now locally controlled by an AT89C52 microcontroller, with a RS-232 link to a PC with linux. All of the six motors are 24 VDC motors driven through two earth switched relays and have two limiting microswitches that stop the drive when closed. The microcontroller drives the linear and rotary Geneve mechanisms to select any position (3 for slits, 4 for filters, 5 for wheel), detecting them with proximity sensors.

In the collimator/camera lenses the position is encoded with a 10K potentiometer, whose output is digitized in the electronics interface. The digital interval is 1865 to 3100.

The two end positions of the in/out mirror are detected with mechanical micro-switches.

The illuminating diffuser for the calibration lamps is moved with a ball screw driven by its corresponding motor. The two ends are detected by mechanical micro-switches, too.

The grating holder position is encoded on the grating rotation axis by a 2500 ppr optical rotary encoder model TRD-N2500-RZWD from Automation Direct (Fig. 5). This gives in quadrature a resolution of 0.036 degrees per pulse, giving a displacement of ~1.08 microns (about 50 pixels) of the spectrum on the CCD per pulse.

A safety shutter placed in the spectrometer output, just in front of the CCD, can be controlled by the microcontroller or by the CCD controller. The shutter control can be released to the CCD controller with a bit acting over a relay.

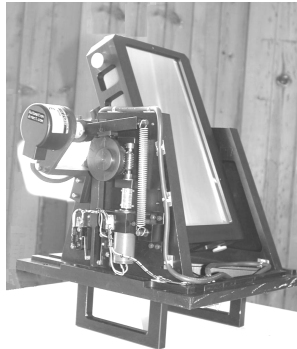

Figure 5. The grating rotation axis is encoded by a 2500 ppr optical rotary encoder.

4. CCD AND IMAGE ACQUISITION

Images are acquired with a cryogenic 1024x1024 SiTe CCD, 24-micron pixels, giving a 5.3' field (0.31"/pixel). The CCD controller from Photometrics (now Roper) is driven by an AT200 card inserted on an embedded Pentium computer with Linux. The software to manage the AT200 is custom made for Linux using some Brian Taylor's libraries² to build the loadable module. The program receives commands from the ethernet network via tcp/ip sockets. There are a few available commands which are listed in the Table 2. The resulting images are sent back to the commands source (another PC with Linux in this case) by mean another socket. This embedded computer is connected to the microcontroller by the RS-232 link, so that it can be close to the CCD controller and to the instrument.

5. THE GUI

To operate the spectrometer, a user interface has been developed and it is now in use instead the previous console (Figs. 6 and 7). Figure 8 shows a block diagram that illustrate the entire layout. This interface is written in Tcl/Tk³ and calls several executable programs written in C. It permits to control the mechanisms for slits, filters, polarizers, an

- xbin** - Defines the serial binning factor
- ybin** - Defines the parallel binning factor
- xorg** - Defines the serial origin for the region to be acquired
- yorg** - Defines the parallel origin for the region to be acquired
- xsize** - Defines the horizontal image size
- ysize** - Defines the vertical image size
- time** - Defines the exposure time
- gain** - Defines the factor gain: low (1) or high (4)
- ccd** - Defines the CCD in use. The available CCDs at SPM Observatory are SiTe 1K 40KHz and 200KHz, and Thomson 2K.
- Expone** - Starts an exposure.

Table 2. Commands available via tcp/ip sockets at the present in the acquisition computer

illuminating diffuser, a grating and an in/out mirror. Also, from this interface the user can start the image acquisition using the Expose button. The shutter can be opened from the GUI if the *local* mode is activated; otherwise, the shutter is opened automatically from the CCD controller.

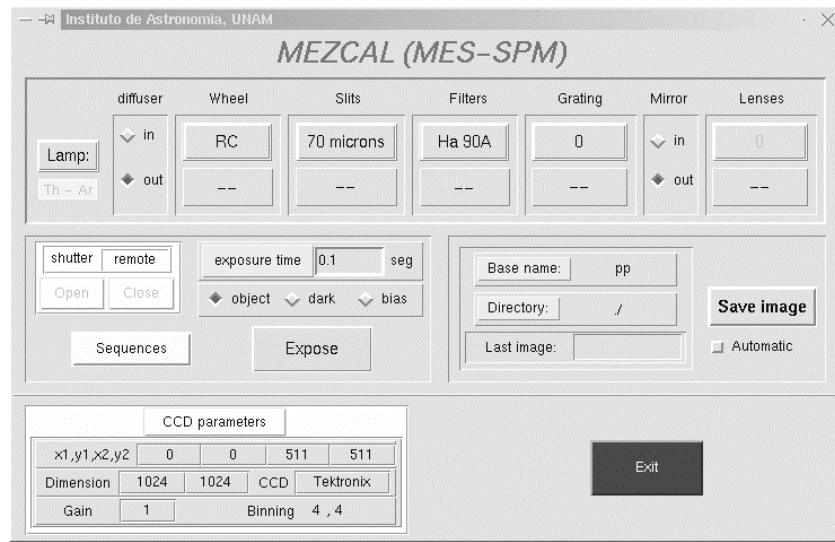

Figure 6. Graphical user interface now used to operate the spectrometer.



Figure 7. Previous console for the spectrometer operation

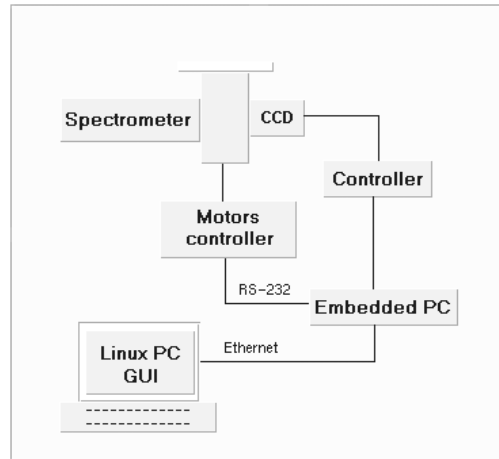

Figure 8. Block diagram that illustrates the entire system layout .

6. OPERATION MACROS

We have implemented a macros language to build sequences intended to optimize the observing run. Table 3 presents a list of the instructions and figure 9 shows four of the sequences loaded as default. The user can build his/her own sequence. In the short term, there will be instructions to interact with move the telescope and the guider.

decr var n	- Decrements variable <i>var n</i> units.
delay n	- Produces a <i>n</i> milliseconds delay.
diffuser in	- Lamp diffuser in.
diffuser out	- Lamp diffuser out.
endloop	- Ends a command loop in a sequence. Nested loops are not allowed.
expon	- Starts a CCD exposition. Exposure time will be that given in the GUI or time <i>t</i> given in the command <i>tint</i> , whatever occurred last. This is in Spanish to maintain compatibility with other applications.
filter n	- Moves filters mechanism to position <i>n</i> , where <i>n</i> can be 0 to 3.
grating m	- Moves the grating holder to position <i>m</i> ; <i>m</i> can be between -70 and 50. The error positioning can be of the order of 1 pulse.
incr var n	- Increments variable <i>var n</i> units.
lamp arc	- Turns on Th-Ar lamp.
lamp off	- Turns off the previous turned on lamp
lamp tun	- Turns on tungsten lamp.
lens m	- Moves the collimator-camera lenses mechanism for focussing to position <i>m</i> . <i>m</i> can be between 1865 and 3100. Commonly, it is not necessary to move the lenses.
loop n	- Stars a loop, repeating <i>n</i> times the code enclosed between <i>loop</i> and <i>endloop</i> .
mirror in	- Mirror to the in position to direct imaging.
mirror out	- Removes the mirror to acquire a spectrum
nbase prefix	- Specify the prefix <i>prefix</i> for the images name.
posmot	- Ask for the motors position.
saveima	- Every image acquired after this instruction will be automatically saved.
shutter close	- Closes the shutter.
shutter open	- Opens the shutter.
slit n	- Moves the slits mechanism to position <i>n</i> , where <i>n</i> can be 0 to 2.
tint t	- Puts the integration time. <i>t</i> must be milliseconds.
variable var value	- Defines the variable <i>var</i> initialized to <i>value</i> .
wheel n	- Moves the wheel to position <i>n</i> , where <i>n</i> can be 0 to 4.

Table 3. List of instructions available to build a sequence.

nombre arc200-150	nombre tungsten300	nombre slit_image_70	nombre focus
tint 200000	tint 300000	tint 100000	loop 20
slit 1	slit 1	slit 0	shutter open
mirror out	mirror out	mirror in	expon
diffuser in	diffuser in	delay 5000	shutter close
delay 25000	delay 25000	posmot	endloop
lamp arc	lamp tun	shutter open	fin
posmot	posmot	expon	
shutter open	shutter open	delay 60000	
expon	expon	shutter close	
delay 200000	delay 300000	slit 2	
shutter close	shutter close	posmot	
lamp off	lamp off	shutter open	
diffuser out	diffuser out	delay 20000	
delay 25000	delay 25000	shutter close	
posmot	posmot	mirror out	
fin	fin	delay 5000	
		slit 1	
		posmot	
		fin	

Figure 9. Some of the sequences load by default. A sequence starts with the word *nombre* followed by the sequence name and ends with the word *fin*.

7. SOME ASTRONOMICAL RESULTS

MES is best used for the study of extended line-emitting nebulae. An example of the data produced by MES is shown in Figure 10. In this figure, individual grey-scale representations of the position-velocity arrays of the [N II] 6584 profiles are shown. The data were obtained with east-west slits that were stepped across the face of a large bipolar nebula (for details see Lopez et al. 1997, ApJ 475, 705). The length of each slit is 5.12 arcmin and the spectral resolution is 10 km/s. Receding velocities are to the top each diagram.

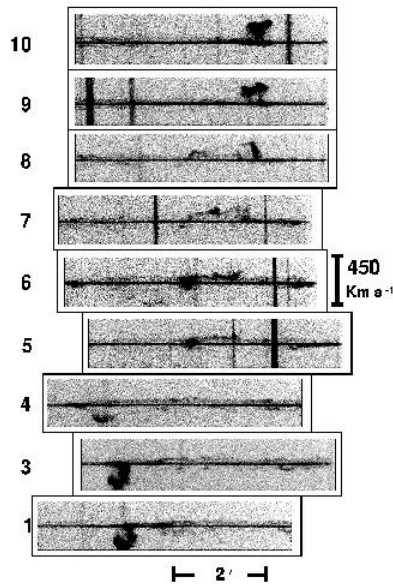

Figure 10.

8. CONCLUSION

MES is a robust and well designed spectrometer and the recent controls upgrading has added efficiency in its operation at the 2.1-m telescope at San Pedro Mártir Observatory. In particular, the possibility of making sequences coordinating automatically the spectrometer movements with the CCD acquisition have dramatically improved the instrument performance and reduced dead times during the observing process.

REFERENCES

1. Meaburn, J., Blundell, B., Carling, R., Gregory, D. F., Keir, D. and Wynne, C. G. "A dedicated echelle spectrometer for the Anglo-Australian Telescope". *Mon. Not. R. Astr. Soc.* **210**, 463-477, 1984.
2. Taylor, B. and Schubert, C. *Series 200 LINUX Developer Kit. (User Manual)*. BII Research, Flagstaff, AZ, 1997.
3. Welch, B. *Practical Programming in Tcl and Tk. Third Edition*. Prentice Hall PTL. Upper Saddle, NJ, 2000.